

AY0080C41

JOHN DEERE		WET WEIGHT			3800 Lbs.	
TANK RUN TIME	TANK CAPACITY	TANK PART #	LENGTH	WIDTH	HEIGHT	ADDITIONAL WEIGHT (EMPTY)
12 Hours	100 GAL	TA0000B71	108"	48"	10"	1000 LBS
24 Hours	200 GAL	TA0000B73	108"	48"	18"	1300 LBS

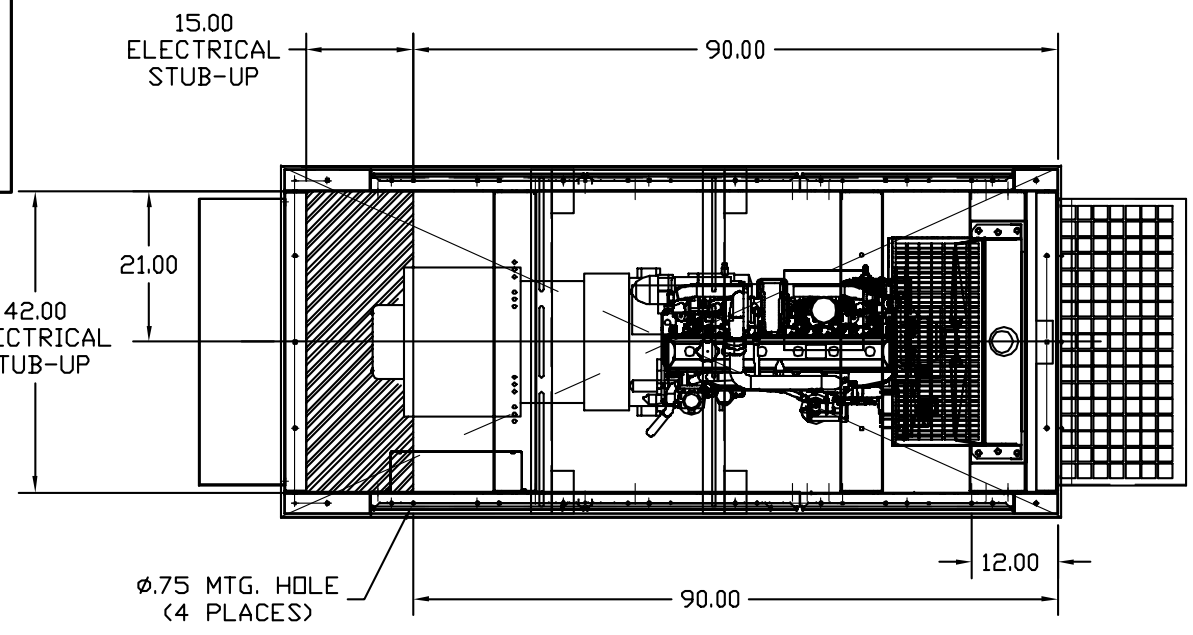

PLAN VIEW

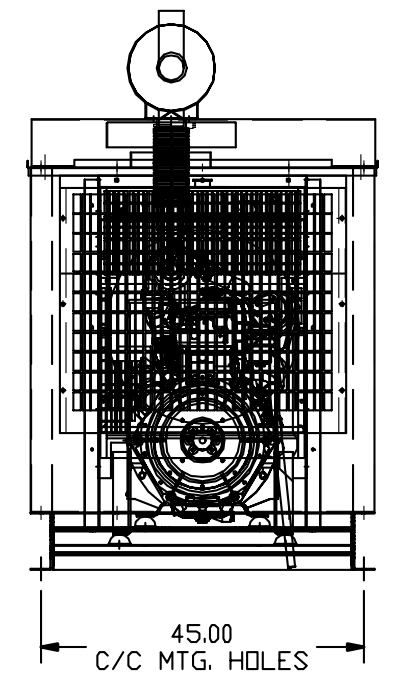

REAR VIEW

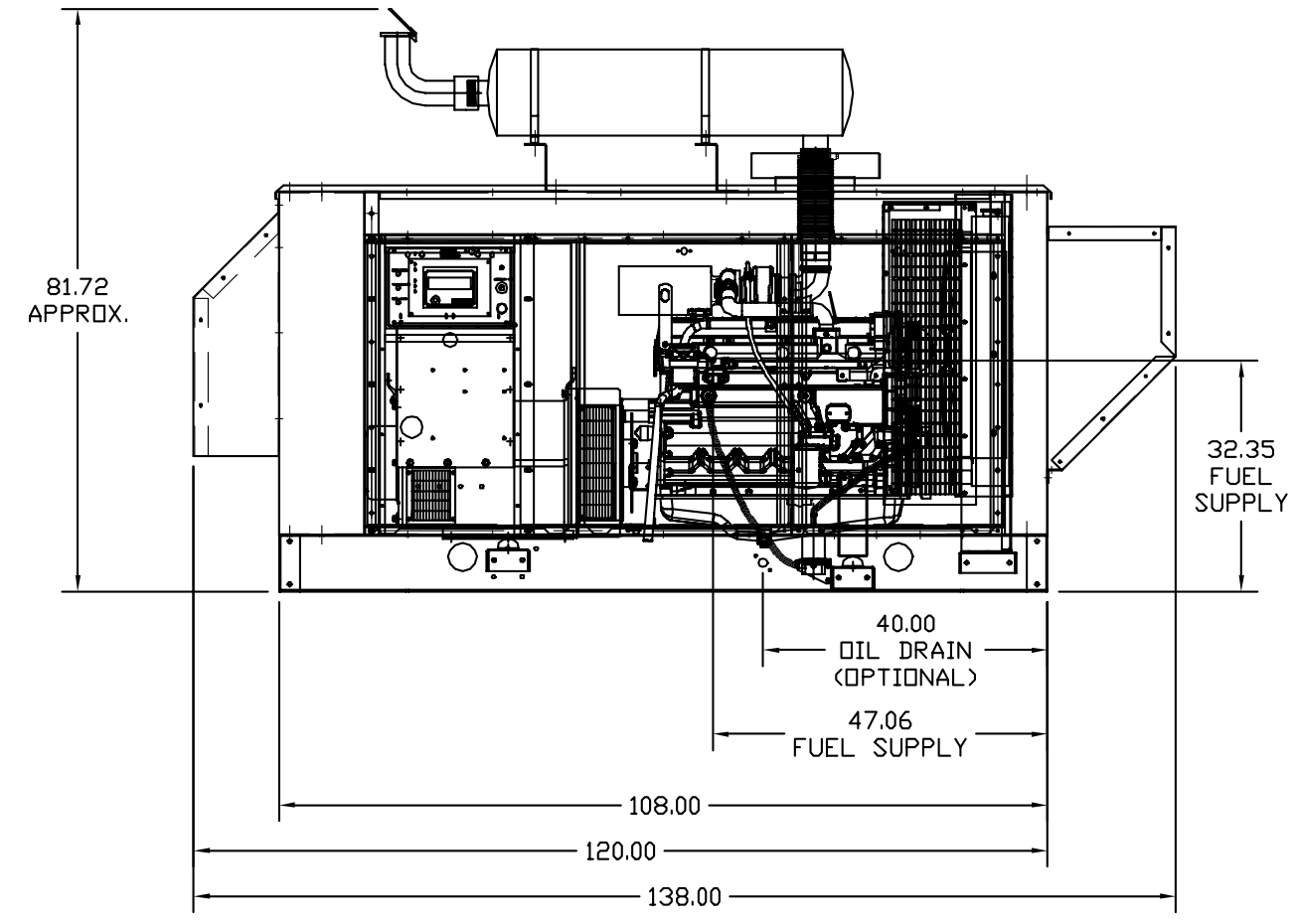

RIGHT VIEW

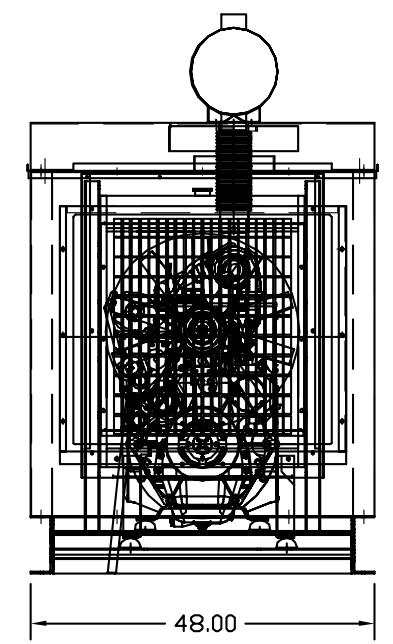

FRONT VIEW

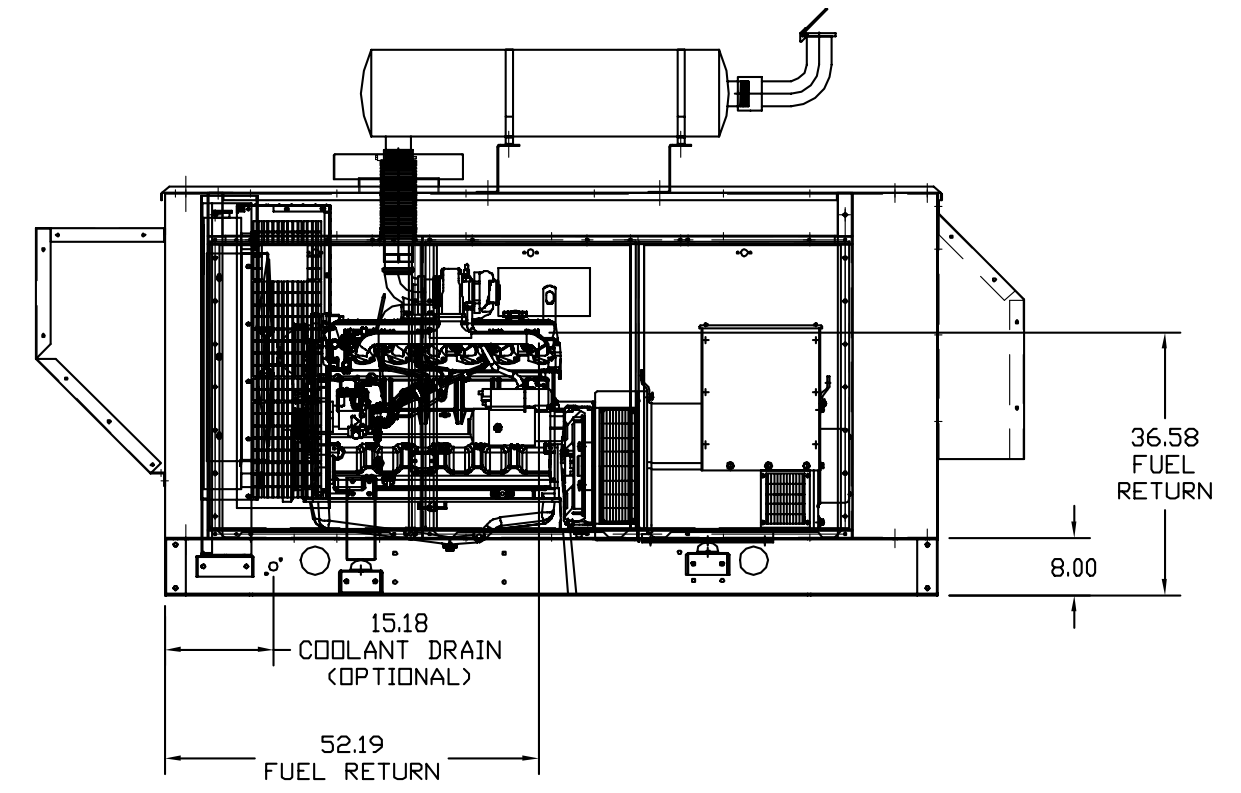

LEFT VIEW

REV. DESC: NEW	VERSION: 00	TDR: 000000339114
REV. LTR: -	REVISED: 15:16:21 11/23/2004	BY: PGJOEE0
FILE: \PGA\00006\200		
MTL: -		

BALDOR ELECTRIC Co.

IDLC100,JD,ECON W/ FOAM,STD

AY0080C41