

AY0080C76

JOHN DEERE		WET WEIGHT			6300 Lbs.	
TANK RUN TIME	TANK CAPACITY	TANK PART #	LENGTH	WIDTH	HEIGHT	ADDITIONAL WEIGHT (EMPTY)
12 Hours	250 GAL	TA0000B42	114"	48"	20"	1300 LBS
24 Hours	480 GAL	TA0000B30	114"	48"	34"	1900 LBS

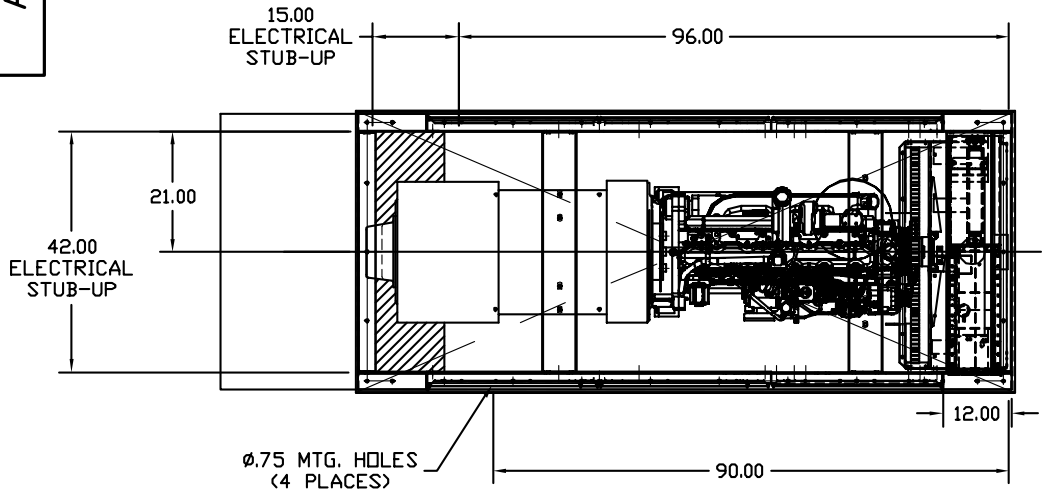

PLAN VIEW

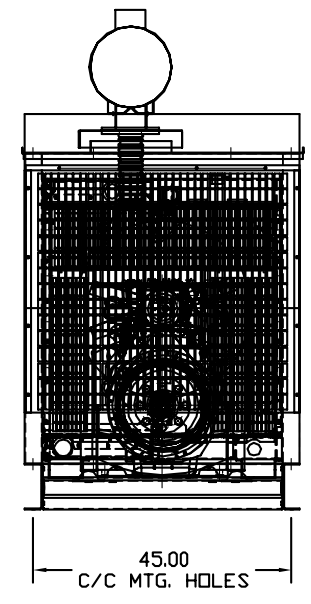

REAR VIEW

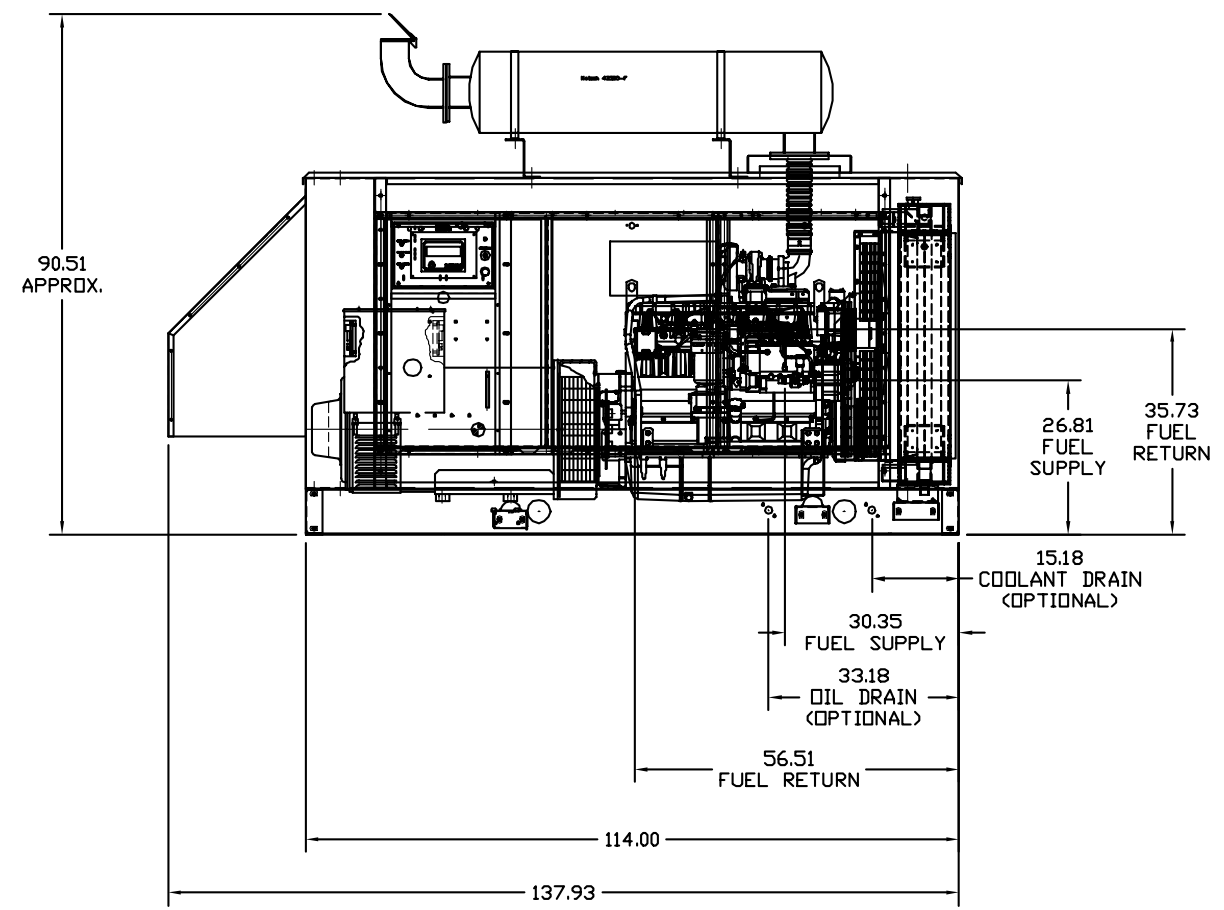

RIGHT VIEW

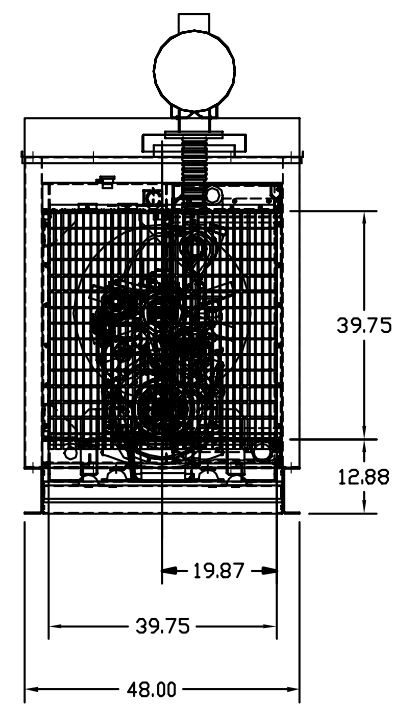

FRONT VIEW

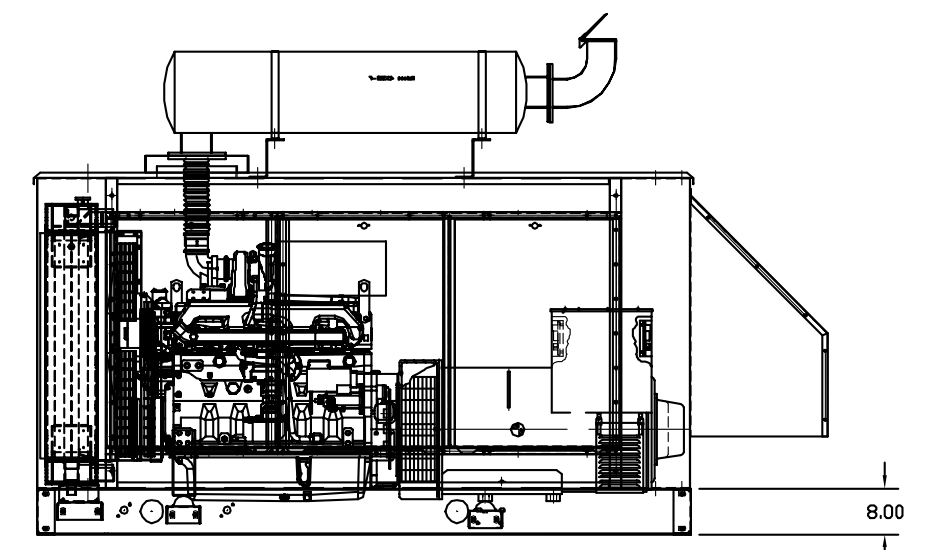

LEFT VIEW

REV. DESC: NEW	VERSION: 00	TDR: 000000339114
REV. LTR: -	REVISED: 10:56:05 11/30/2004	BY: PGJOEEO
FILE: \PGA\00006\262		
MTL: -		

BALDOR ELECTRIC Co.

IDLC250,JD,ECON,STD

AY0080C76