

AY0080C04

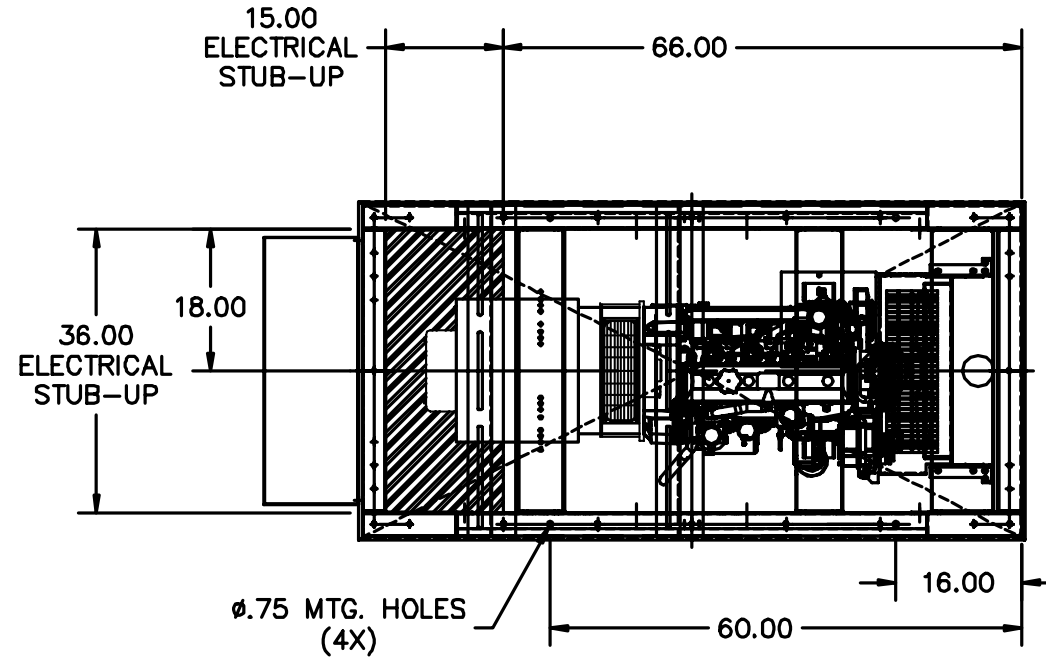

PLAN VIEW

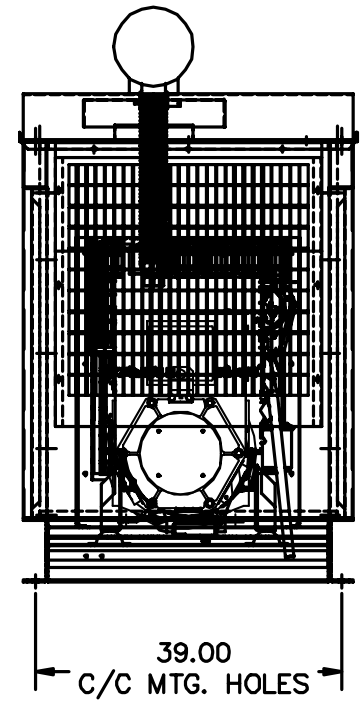

REAR VIEW

JOHN DEERE		WET WEIGHT				3000 Lbs.
TANK RUN TIME	TANK CAPACITY	TANK PART #	LENGTH	WIDTH	HEIGHT	ADDITIONAL WEIGHT (EMPTY)
12 Hours	50 GAL	TA0000B36	84"	42"	10"	600 LBS
24 Hours	90 GAL	TA0000B51	84"	42"	15"	900 LBS

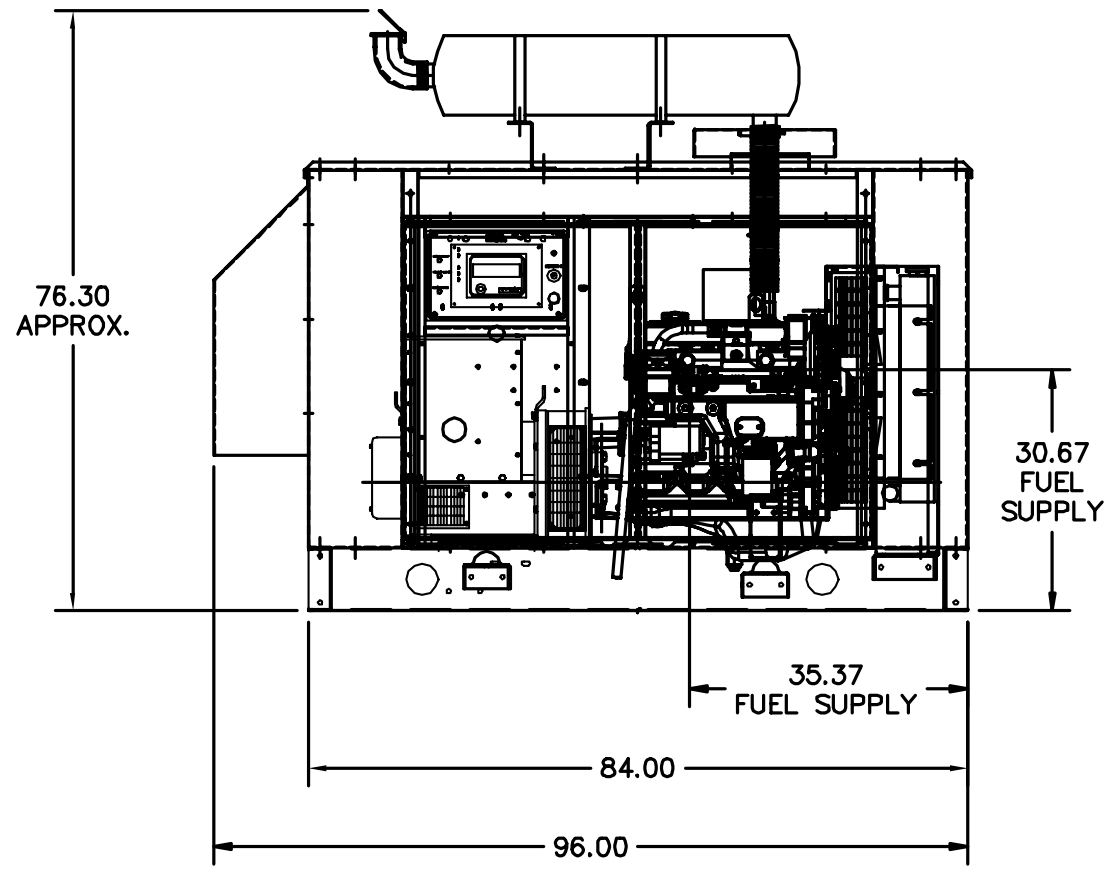

RIGHT VIEW

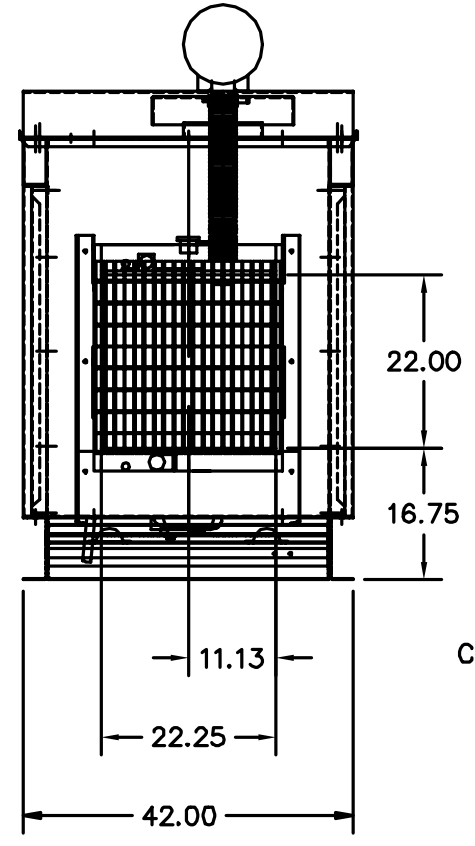

FRONT VIEW

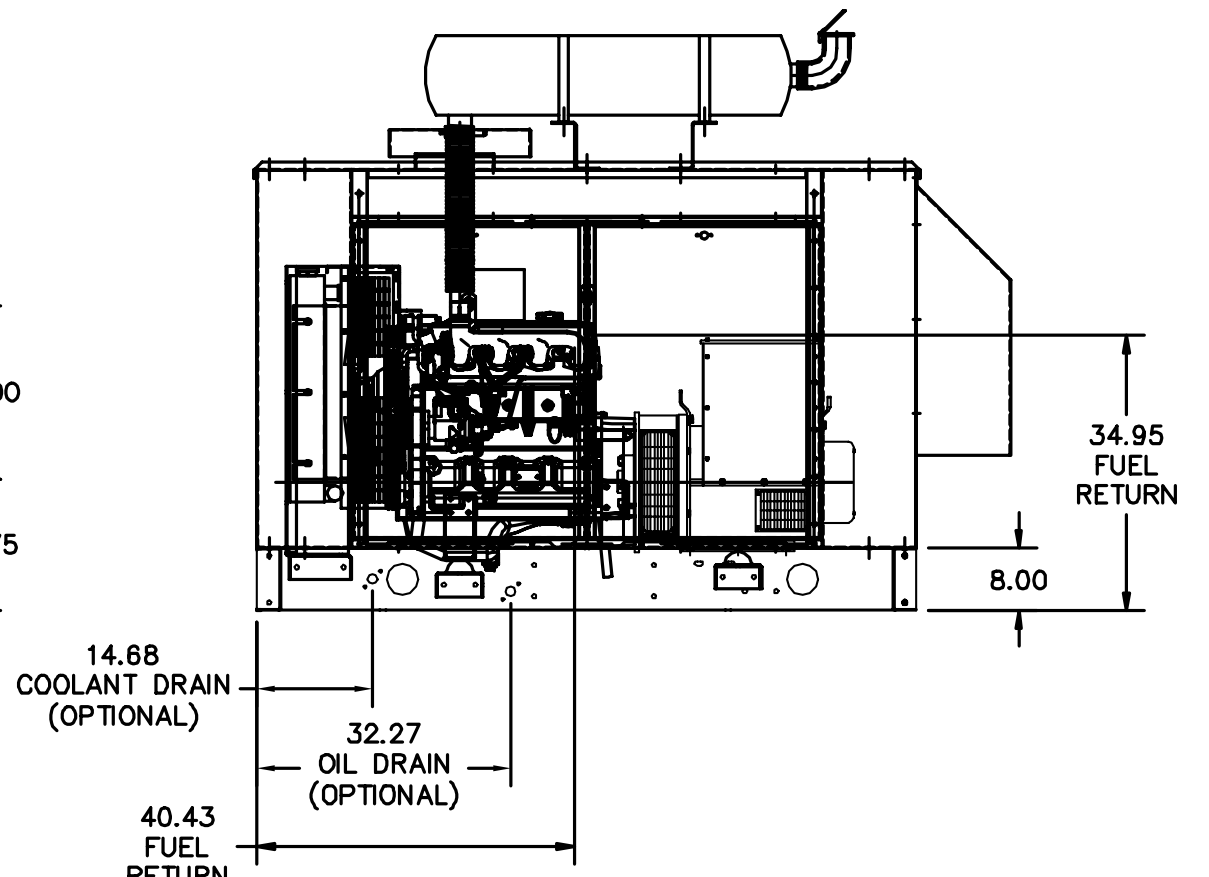

LEFT VIEW

REV. DESC: NEW	VERSION: 00	TDR: 000000339114
REV. LTR: -	REVISED: 14: 41: 37 11/23/2004	BY: PGJOEE0
FILE: \PGA\00005\856		
MTL: -		

**BALDOR ELECTRIC Co.**

IDLC30,JD,ECON,STD

AY0080C04