

AY0080C11

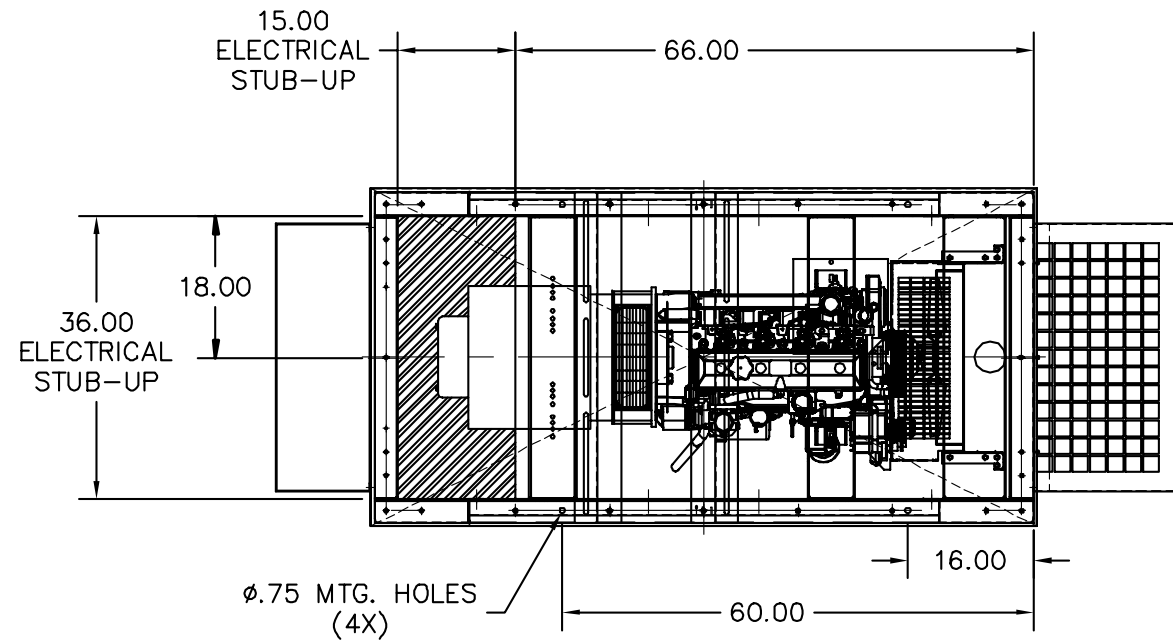

PLAN VIEW

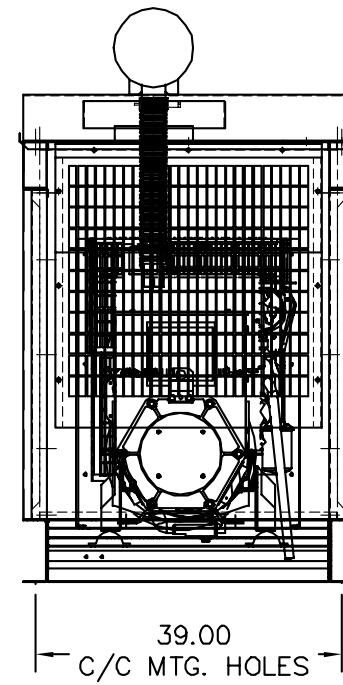

REAR VIEW

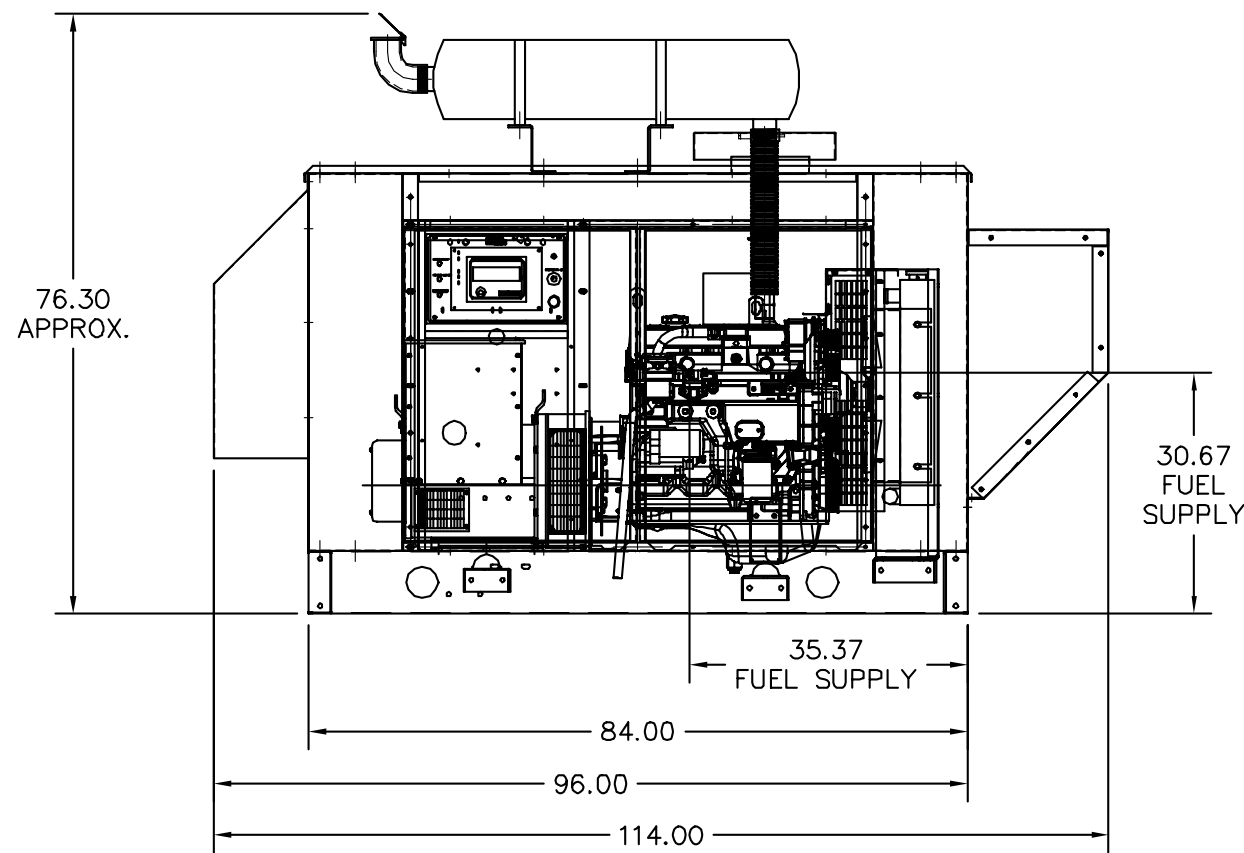

RIGHT VIEW

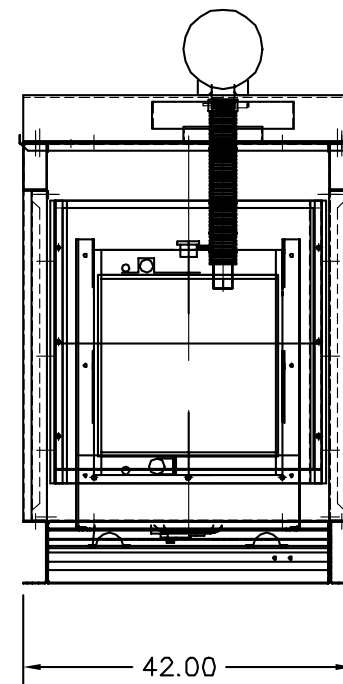

FRONT VIEW

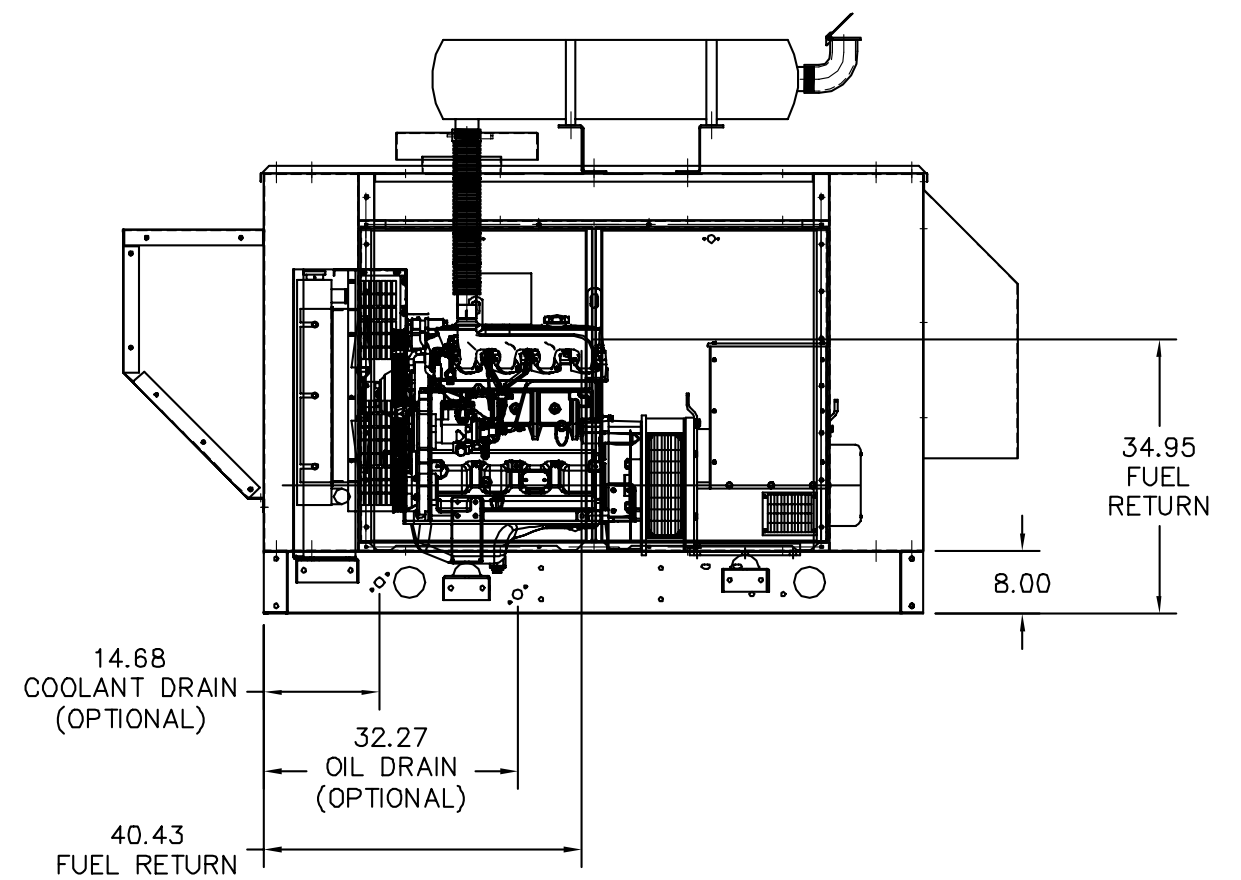

LEFT VIEW

JOHN DEERE		WET WEIGHT				3060 Lbs.
TANK RUN TIME	TANK CAPACITY	TANK PART #	LENGTH	WIDTH	HEIGHT	ADDITIONAL WEIGHT (EMPTY)
12 Hours	50 GAL	TA0000B36	84"	42"	10"	600 LBS
24 Hours	90 GAL	TA0000B51	84"	42"	15"	900 LBS

REV. DESC: NEW	VERSION: 00	TDR: 000000339114
REV. LTR: -	REVISED: 10:04:09 11/23/2004	BY: PGJOEE0
FILE: \PGA\00005\865		
MTL: -		

**BALDOR ELECTRIC Co.**

IDLC40,JD,ECON W/ FOAM,STD

AY0080C11