

AY0080C35

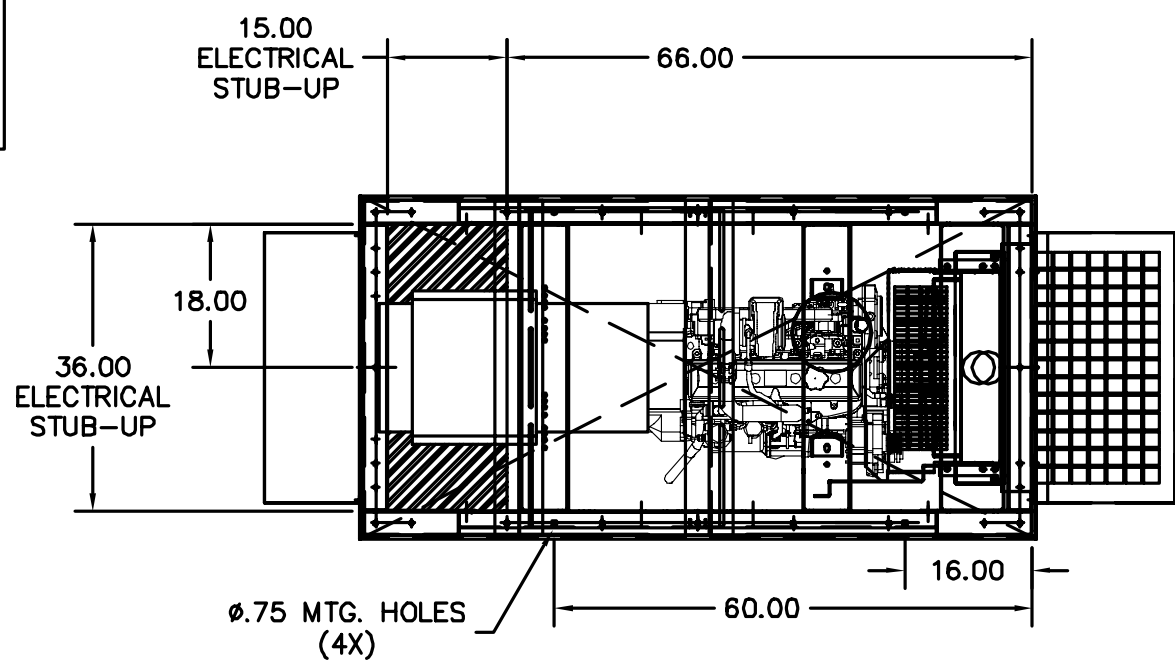

PLAN VIEW

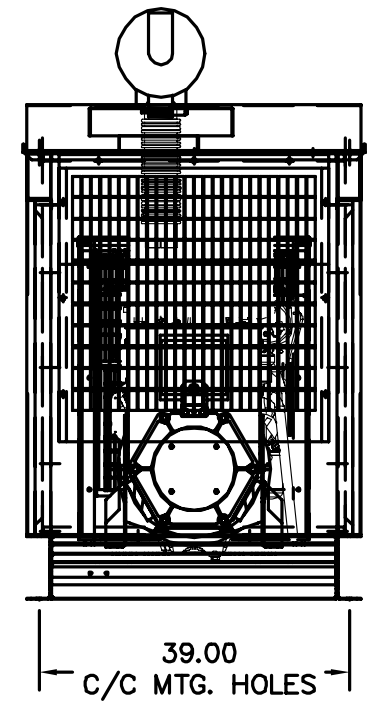

REAR VIEW

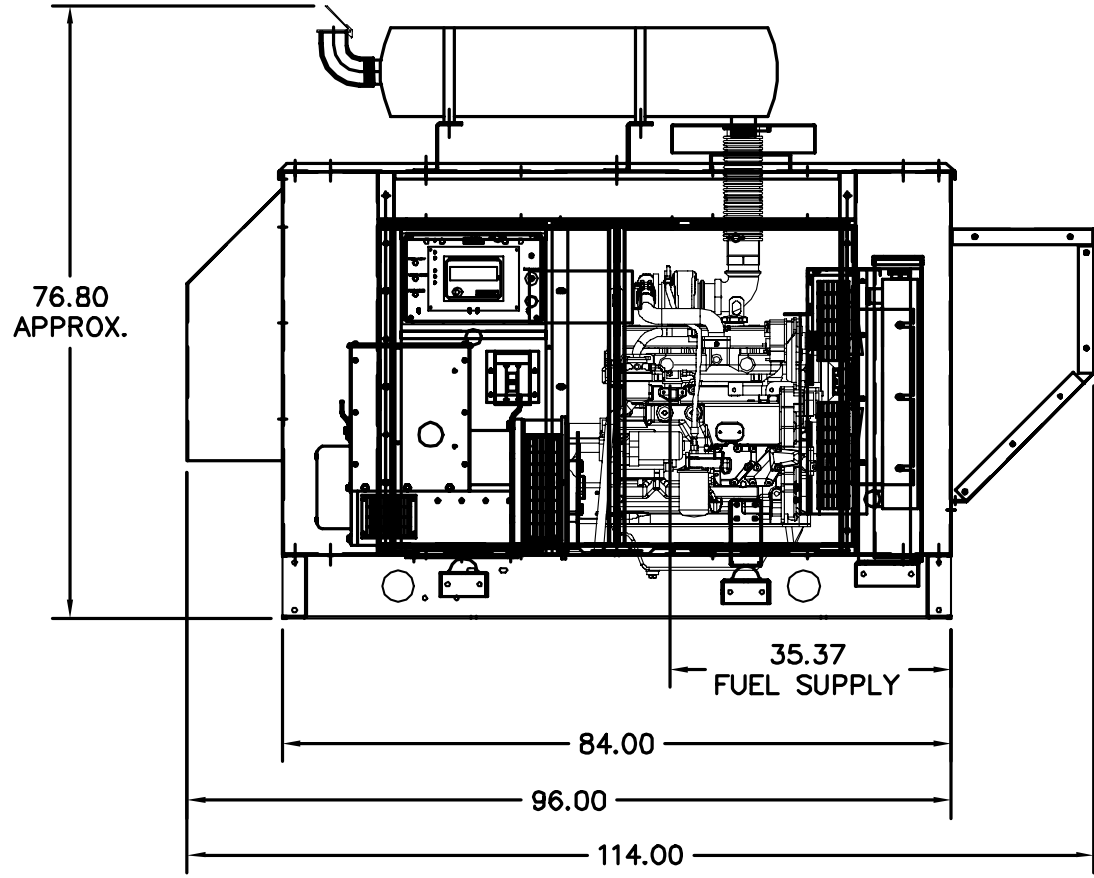

RIGHT VIEW

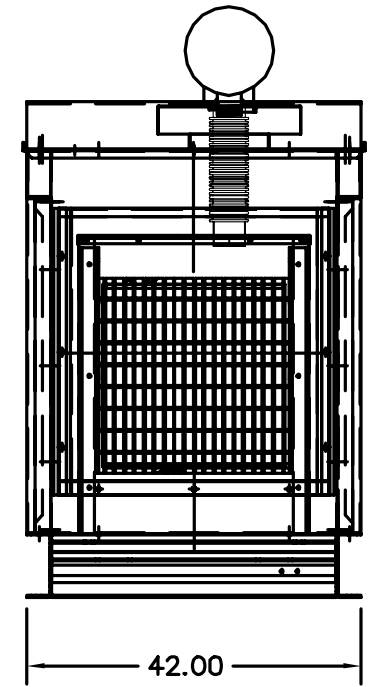

FRONT VIEW

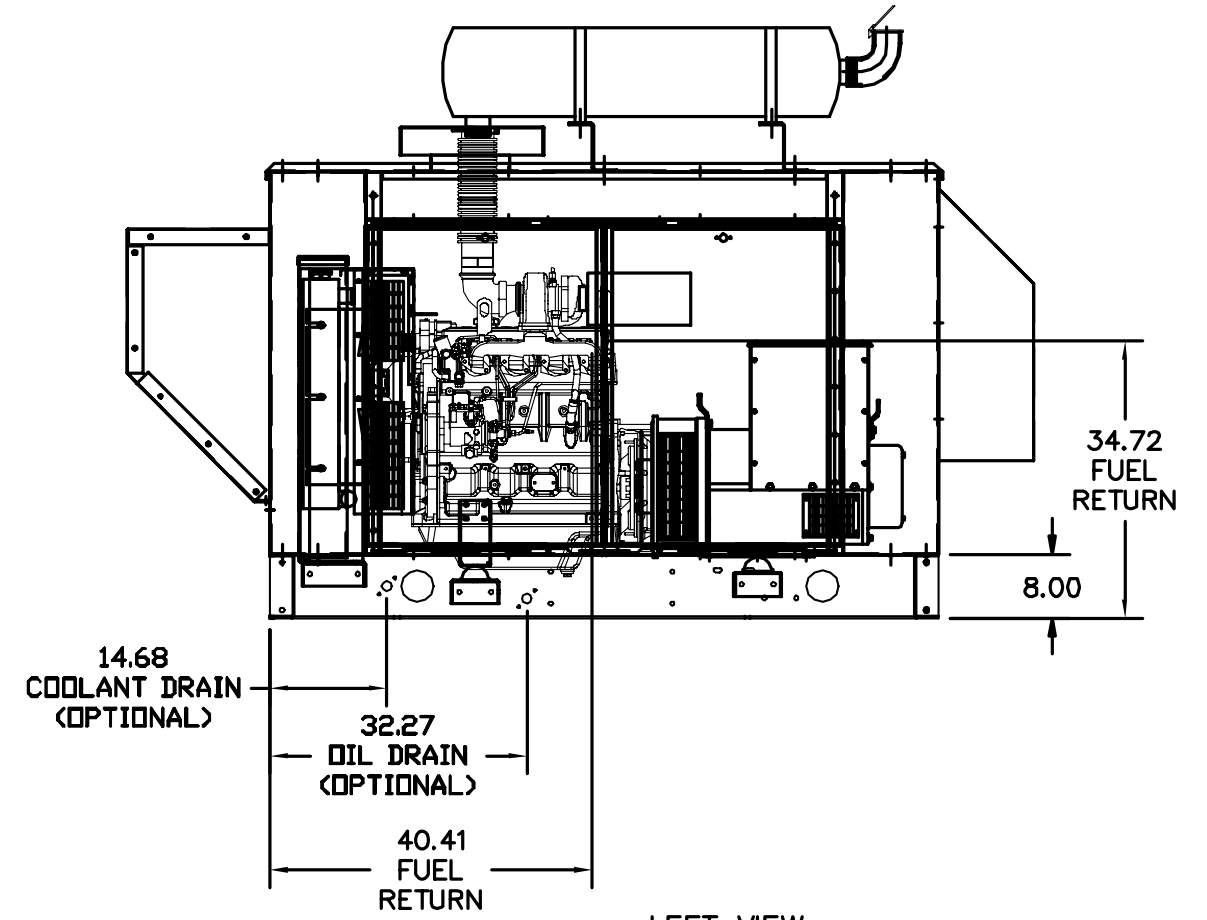

LEFT VIEW

JOHN DEERE		WET WEIGHT				3150 Lbs.
TANK RUN TIME	TANK CAPACITY	TANK PART #	LENGTH	WIDTH	HEIGHT	ADDITIONAL WEIGHT (EMPTY)
12 Hours	80 GAL	TA0000B75	84"	42"	12"	800 LBS
24 Hours	150 GAL	TA0000B43	84"	42"	24"	1100 LBS

REV. DESC: NEW	VERSION: 00	TDR: 00000339114
REV. LTR: -	REVISED: 08:47:05 11/24/2004	BY: PGRICLO
FILE: \PGA\00005\892		
MTL: -		

BALDOR ELECTRIC Co.

IDLC80,JD,ECON W/ FOAM,STD

AY0080C35